



14.1" Notebook
Instruction Manual

Contents

Getting Started	03		
Box Contents	03		
Product Overview	04		
Device Description	04		
Features	06		
Desktop Layout	07		
About The Screen	08		
Using The Notebook	09		
Before First Use	09		
Starting Up	09		
Notebook Power	10		
Connections	11		
WiFi	11		
User Interface	12		
Start Menu	12		
Moving a Desktop shortcut	13		
Removing a Desktop Shortcut	13		
Cortana Search	13		
Windows Action Centre	13		
		Changing your wallpaper and themes	14
		To download new apps	14
		External Storage	15
		Inserting a Memory Card	15
		Formatting a microSD card	15
		Data Management & Security	16
		Backing up your Notebook	16
		Improving security on your Notebook	16
		Product Support	18
		Troubleshooting	18
		Specification	19
		Safety Information	20
		After Sales Support	22
		Product Guarantee (UK Only)	22
		Disposal Information	22

Getting Started

Congratulations on choosing to buy an Entity product. All products brought to you by Entity are manufactured to the highest standards of performance and safety. Before use, please read this manual carefully. It gives important instructions about safety, use and maintenance of your Notebook.

We hope you enjoy using your purchase for many years to come. Remove all packaging material. You may wish to keep the packaging for future use or storage of your Notebook. Alternatively, dispose of accordingly.

Box Contents

When opening the box please ensure that the items listed below are included within. If an item is missing please contact where you purchased the item.

- 11.6" 360 Notebook
- Power Adaptor
- Instruction Manual

Product Overview

Device Description

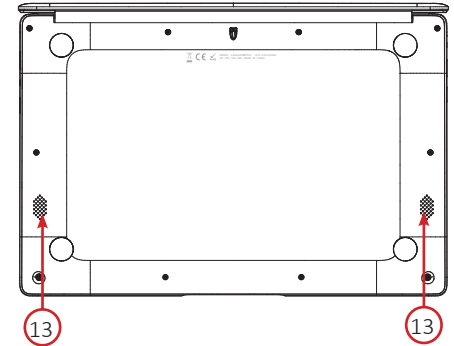
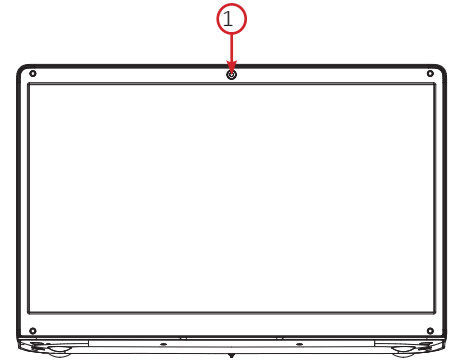
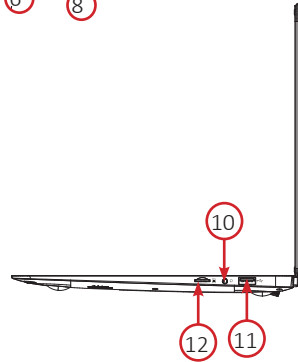
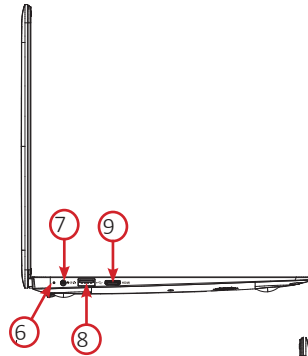
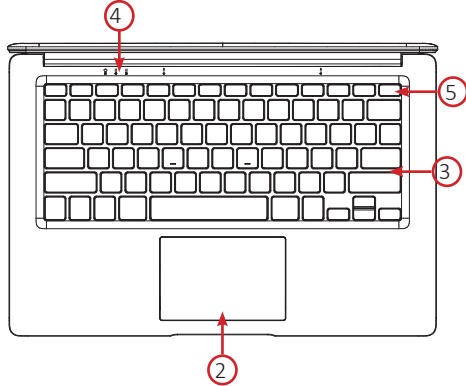
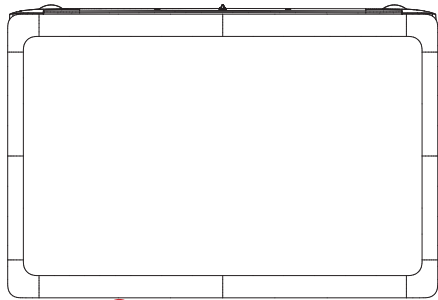

Name		Descripton
1	Camera	2MP Front-Facing Camera.
2	Touchpad	Control your notebook.
3	Keyboard	Input data into your notebook
4	Indicators	Caps Lock, Charging and Power lights.
5	Power	Press to turn the unit on, or to turn the screen on or off. Press and hold to access the Power Off menu.
6	Charge Indicator	Lights up when charger is plugged in and working.
7	DC Charging Port	Port to plug in included charger.
8	USB	USB 3.0 x1
9	Mini-HDMI	Port for mini-HDMI cable connection.
10	Aux Jack	Audio output connection for headphones.
11	USB	USB 2.0 x1
12	micro-SD port	Insert micro SD card to expand notebook storage.
13	Speakers	Base speakers for audio output.

Features

Browse the Web

Visit your favourite websites.

Check your e-mail

Keep in touch with friends and family.

Watch Youtube™ videos

Browse the world's most popular video-sharing community.

Discover thousands of apps for Windows™

Games, applications and more with the installed market place.

Enjoy your media library anywhere

Portable powerhouse plays your chosen music, videos and photos.

microSD memory card reader

Browse the world's most popular video-sharing community.

Built-in camera

Convenient front-facing and rear-facing cameras.

Desktop Layout



About The Screen

This Notebook is equipped with an easy to use touch screen.

Protective Film:

A thin film has been applied to the screen to protect it during shipping. This film should be removed before the Notebook is used. To remove, simply take a corner of the film and peel away from the screen.

Note: Do not use any sharp object to remove film as this could cause damage to the screen

Using The Notebook

Before First Use

- Ensure that the notebook is charged fully before first use.
- Ensure that you have a good wifi connection, with your network name and password available.

Starting Up

Turn on the device by holding in the power button for 2/3 seconds.

The first time you use your device, the startup wizard will help you set up your device:

- Language
- Date & Time
- WiFi Connection
- Location service options
- Third-party applications
- Necessary Updates
- Account Synchronization

Notebook Power

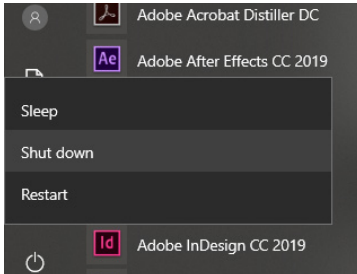

Turning The Notebook On or Off:

- To turn the Notebook on:

Press and hold the Power key until the screen turns on. Wait until the Desktop screen appears; the Notebook is now ready for use.

- To turn the Notebook off:

Press the start button and click on the power icon. This then gives the option to shutdown sleep or restart.

Turning the Screen On or Off:

When the Notebook is on, you can turn off the screen to conserve power and protect the screen. Simply press the start button and click on the power icon, then choose sleep.

NOTE: To conserve battery power, the screen can be set to turn off automatically when the Notebook is not in use (between 1 minute and 5 hours). The screen timeout option can be found in the display menu.

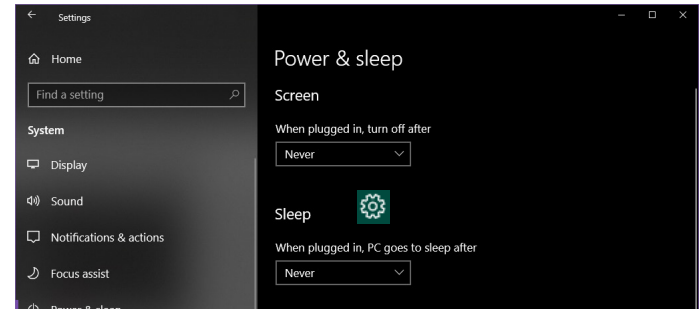

It is strongly recommended that you sign into/register for a Windows account (needed for the installation of new apps). When prompted it is also recommended that you agree to backing up your notebook. This creates copies of all of your files should you ever need to restore the Notebook.

Connections

WiFi

The Notification bar displays icons that indicate your Notebook's Internet status.



Connected to a Wi-Fi network (waves indicate connection strength).



There are no Wi-Fi networks in range, or the Wi-Fi is not connected.

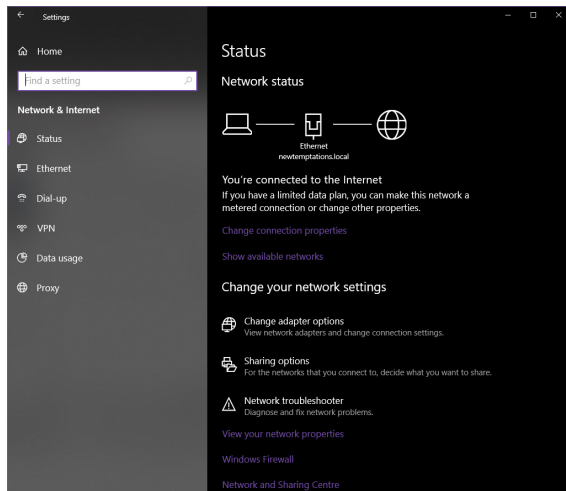

Open the Settings menu by pressing the start button and clicking on the cog/settings icon .

Note: Settings icon can also be found on the desktop.

Open the Network and Internet menu and turn the WiFi on.

Select your network from the list of available networks.

The Notebook will prompt you to confirm connection to the network. Touch Connect to confirm. If the network is secured (as indicated by a Lock icon), the Notebook will prompt you to enter a password or other credentials.

User Interface

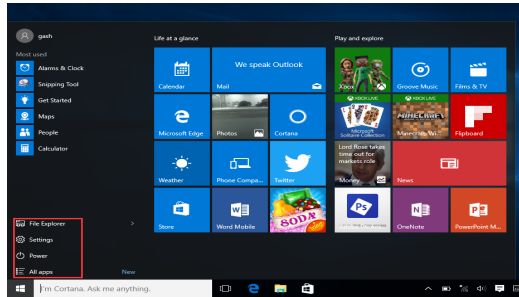

Start Menu

To open the start menu select the icon  in the bottom left hand corner of the Notebook desktop. Once the menu has been opened you will be greeted with a variety of options.

Applications

Once in the start menu, a list of all installed applications is visible, sorted alphabetically. Tiled shortcuts will appear on the right for selected pre-installed applications. There is also the option to add tile shortcuts for easier access to your most used applications.

Adding a shortcut tile to start menu

Click the start button. Right click on an application icon and select pin to start. This will create a tile in the start menu for the selected programme.

Removing shortcut tile from start menu

Click the start button. Right click on an application tile and select unpin from start. This will remove the desired program from the start menu but not from your Notebook.

Adding shortcut to the taskbar

Click the start button. Right click on an application tile and select pin to taskbar. This will add the application icon to the taskbar at the bottom of your screen.

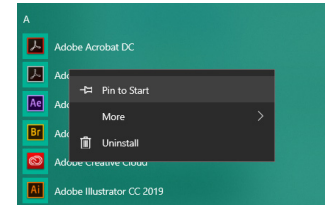



Moving a Desktop shortcut

Click and hold onto the icon you wish to move. As you drag the icon it will become semi-transparent. You can then slide it to the desired location, and then release your the mouse.

Removing a Desktop Shortcut

Right click on an application icon and select delete from the drop down menu that appears.

Cortana Search

Windows 10 comes with the feature of Cortana. This is a search feature on the task bar. To use this click into the search bar and type what you wish to search for. This can be a feature or setting on your device, or on the web.

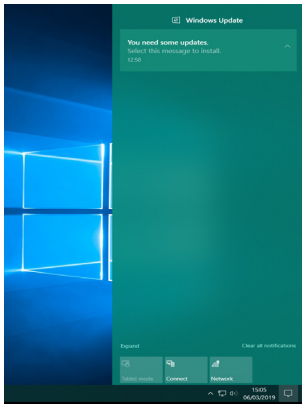
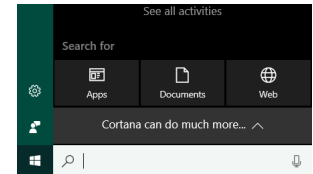



Windows Action Centre

The Action Center is where you'll find application notifications and quick actions. On the taskbar, look for the Action Center icon . The Action Center allows access to quick settings, in the form of small boxes at the bottom of the panel.

Notifications within the action centre are sorted into categories by app, and users can click a small 'x' to clear notifications.

The Action Center also supports actionable notifications, such as recent text messages, emails or social media integration.

Changing your wallpaper and themes

Press start  and select the settings icon . Select the personalisation menu where you will be greeted with the options to change your background/theme for the Desktop and lockscreen. In this section you also have the option to change the Windows accent colours and choose which elements will use the colour.

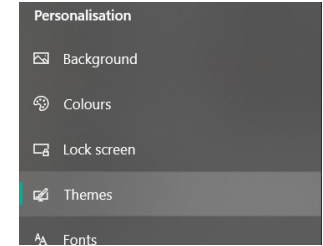

To download new apps

To install new apps approved by Windows, click the Windows Store icon on the bottom task bar. There you will find over 1 million apps including many of which are free. Even if you only going to use free apps you will still need to create a Windows account but you dont need to enter your credit card details to do this.

External Storage

Inserting a Memory Card

This Notebook accepts microSD memory cards. This allows you to increase the memory capacity of your Notebook and also to play media files that are stored on the memory card (e.g. music, photos or video files).

To insert a memory card:

- Align the memory card with the microSD slot. The metal portion of the memory card should be facing away from the screen.
- Push the card into the slot, until you hear a click. This signifies that the card is locked into place.

Do not attempt to insert objects other than a SD card into the card slot. A compatible memory card should fit easily into the card slot. If the card will not easily fit, check the alignment of the card. Do not attempt to force it into the slot. Avoid touching the metallic contacts of the memory card.

Formatting a microSD card

Note: Formatting an SD card will wipe any and all data from the SD card's storage. If you wish to retain any files please transfer them onto a Notebook or other device before formatting.

- Please ensure the correct drive is selected before formatting. Once formatted this cannot be undone.
- Open File Explorer by clicking on the icon  on the task bar and navigate to "This PC"
- Find the drive where your SD Card is Located
- Right-click, and when the menu appears click Format.

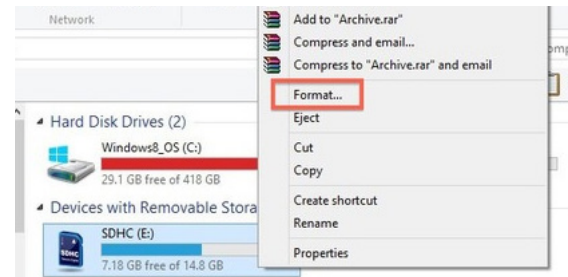

Data Management & Security

Backing up your Notebook

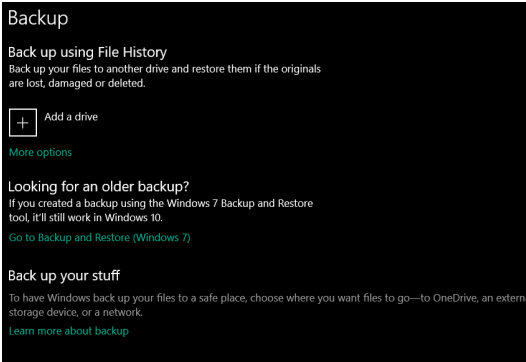

File History

Use File History to back up to an external drive or location. Select the Start button > Settings > Update & Security > Backup > Add a drive , and then choose an external drive or network location for your backups.

If you're missing an important file or folder that you've backed up, here's how to get it back:

In the search box on the taskbar, enter Restore files, and then select Restore your files with File History. Look for the file you need, then use the arrows to see all its versions. When you find the version you want, select Restore to save it in its original location. To save it in a different place, press and hold (or right-click) Restore, select Restore to, and then choose a new location.

Improving security on your Notebook

Online

In order to avoid online threats we recommend that you install antivirus and security software on your device immediately after set up and keep these, your internet browser and other software up to date to take advantage of security fixes.

Physical theft

If you store valuable information on your Notebook including passwords and logins for personal accounts etc. you may want to enhance the security of your Notebook in case it is stolen or lost. This includes enforcing the log in with your windows account and a PIN.

Erasing your personal data

If you sell your Notebook on, or discard it you should erase the data in memory, before you do so. This securely erases your data so that it cannot be recovered. Please note that simply returning your Notebook to factory settings is not a reliable way of erasing your personal data (unless you have first encrypted your data).

Encrypting your data

Sign in to Windows with an administrator account. Select the Start button , then select Settings  > Update & Security > Device encryption. If device encryption is turned off, select Turn on.

If device encryption is not available on your device, follow these steps to turn on standard BitLocker encryption instead:

Sign in to your Windows device with an administrator account. In the search box on the taskbar, type Manage BitLocker and then select it from the list of results. Select Turn on BitLocker and then follow the instructions. (If BitLocker is turned on and you want to turn it off, select Turn off BitLocker.)

Product Support

Troubleshooting

Your PC isn't working well and you recently installed an app.	Restore from a system restore point
Your PC isn't working well and you recently installed an update.	Remove an installed Windows update
Your PC won't start and you've created a recovery drive.	Use a recovery drive to restore or reset your PC
Your PC won't start and you haven't created a recovery drive.	Use installation media to restore or reset your PC
Your PC won't start, you haven't created a recovery drive, and resetting your PC didn't work.	Use installation media to reinstall Windows 10
You want to reinstall your previous operating system.	Go back to your previous version of Windows

Specification

Operating system:	Windows 10
CPU:	Intel Cherry Trail Z8350
GPU Processor:	Intel® HD Graphics (Gen 7)
Internal RAM:	2GB
Internal Flash:	32GB
Display:	10.1" Screen
Resolution:	800*1280 IPS
TP:	Main Panel Touch Screen
Memory Card:	SD Card up to 32GB
WIFI Module	WIFI 802.11b/g/n+BT
I/O:	USBX1, 3.5mm earphone jack x 1 SD card x 1 , DC connector
Bluetooth:	4.0

Safety Information

WARNING - To reduce the risk of fire, electric shock, or injury:

- DO NOT expose the Notebook to high temperatures, direct sunlight, moisture, rain or a highly dusty environment.
- DO NOT use the Notebook in prohibited areas (ie; airplanes).
- DO NOT use the Notebook whilst driving or walking.
- DO NOT dispose of the Notebook in a fire to avoid explosion.
- DO NOT disconnect the Notebook from the mains power supply by pulling the cord, switch it off and remove the plug by hand.
- DO NOT attempt to disassemble the Notebook, or use alcohol, thinners or benzene to clean the Notebook as this will cause damage to the unit.
- DO NOT disassemble, repair or modify the Notebook by yourself. Refer servicing to qualified personnel only.
- Never subject the Notebook to any heavy impact such as dropping or shaking.
- Keep away from magnetic sources.
- It is not recommended to use the headphones at a high volume for an extended period of time as this may cause damage to your hearing.
- Once the casing has been tampered with, the company shall not be liable for any resulting damages or faults.
- Clean with a dry cloth only. Make sure the Notebook is turned off before cleaning. Do not use liquid or abrasive cleansers.
- Only use this Notebook for its intended domestic use. Entity will not accept any liability if the Notebook is subject to improper use, or failure to comply with these instructions.

- Keep the Notebook and its power supply cord away from heat or sharp edges that could cause damage.
- Keep the power supply cord away from any parts of the Notebook that may become hot during use.
- Use of an extension cord with the Notebook is not recommended.
- This Notebook should not be operated by means of an external timer or separate remote control system.
- Keep the Notebook away from flammable materials.
- Avoid dropping the Notebook. Do not allow the display screen to become damaged as this cannot be replaced/ repaired.
- When the Notebook is formatting or a file is uploading or downloading, do not suddenly disconnect the Notebook from the external sources as this could cause an application error.
- The company reserves the right to improve the product specification and design. The information is subject to changes without prior notice.
- This Notebook has no waterproof function.

After Sales Support

If you need help using your product, please contact Giani Ltd:-

- Telephone: 0161 480 6204.
- Email: info@gianiuk.co.uk.
- Website: www.gianiuk.co.uk.

(Replacement instruction manuals are available to download from the website).

PRODUCT GUARANTEE (UK ONLY)

If your product ceases to function within 1 year from the date of purchase, the retailer will replace it free of charge, provided:

- You have not misused, neglected or damaged it.

There is a fault with your products hardware and not the Notebooks software.

- It has not been modified (except by Giani Ltd).
- It was not purchased second hand.
- It has not been used commercially.
- You can supply proof of purchase, indicating the price you paid and where and when the product was purchased.

This guarantee does not affect your statutory rights.

DISPOSAL INFORMATION

IMPORTANT INFORMATION FOR CORRECT DISPOSAL OF THE PRODUCT IN ACCORDANCE WITH EC DIRECTIVE 2002/96/EC

At the end of its working life, the product must NOT be disposed of as urban waste. It must be taken to a special local authority differentiated waste collection centre or to a dealer providing this service. Disposing of a household product separately avoids possible negative consequences for the environment and health deriving from inappropriate disposal and enables the constituent materials to be recovered to obtain significant savings in energy and resources. As a reminder of the need to dispose of household products separately, the product is marked with a crossed-out wheeled dustbin.



J.D.Williams
Manchester, M60 6ES

